

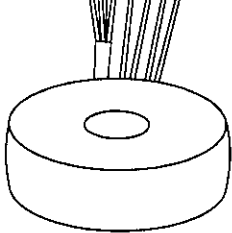

Typ Type	: 1~ Sicherheitstransformator 1~ Safety isolating transformer		
Kernform Core type	: Ringbandkern Toroidal		
Bemessungsspannung, Eingang Designated input voltage	: 2x115V		
Bemessungsstrom, Eingang Designated input current	: 0,30Aac		
Bemessungsspannung, Ausgang Designated output voltage	: 2x 15V		
Bemessungsstrom, Ausgang Designated output current	: 2,0Aac		
Vorzusehende Absicherung, Ausgang Recommended output fuse	:  2,0AT		
Einschaltdauer Duty cycle	: 100%		
Bemessungsleistung (bei Leistungsfaktor 1) Designated output power (power factor 1)	: 60VA		
Verlustleistung Power loss	: ca. 10,5W (η ~ 85,0%) approx.		
Schaltgruppe Connection mode	: IIIi0		
Betriebsfrequenz Designated frequency	: 50-60Hz		
Schutzklasse Safety class	: vorbereitet für Geräte der Schutzklasse II prepared for class II equipment		
Schutzart Protection index	: IP00		
Kühlungsart Type of cooling	: AN		
Isolierstoffklasse Insulation class	: B (UL class 105)		
Max. Umgebungstemperatur Ambient temperature	: 40°C		
Vorschriften Standards	: EN 61558 Teil 1 mit Teil 2-6 EN 61558 part 1 with part 2-6		
Prüfzeichen Approvals	:  UL 5085, CSA 22.2 (E 103521)		
Prüfspannung HV-Test voltage	: Primär-Sekundär 4,8 kV Sekundär-Sekundär 0,3 kV Primary-Secondary Secondary-Secondary		
	: Primär-Primär 0,3 kV Primary-Primary		
Anschluß (Eingang) Terminal (Input)	: 20-21cm UL/CSA-Litze Style 1015 AWG 20 20-21cm UL/CSA- AWM style 1015 AWG 20		
Anschluß (Ausgang) Terminal (Output)	: 20-21cm Drahtenden mit Gewebeschauch 20-21cm wire insulated with glass reinforced sleeving		
Bemerkungen Notes	: Die angegebenen technischen Daten sind typisch. Material-und fertigungsbedingt können Abweichungen auftreten. Technical specifications are typical, they can vary due to material and production tolerances.		

a	Date: 22.04.13	Name: Schlee	Date: 25.4.13	Checked: 	Amendment: Abmessungen, Gewicht, Eingangsleitung geändert/ Dimension, weight, input wire changed
	Date: 04.06.10	Date: 02.07.10	Schutzvermerk nach ISO 16016 beachten Observe protection clause to ISO 16016		Änderungen vorbehalten Subject to change
	Name: Jochade	Checked: Thomas			

Anschlußkennzeichnung:
 Terminal Identification

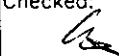
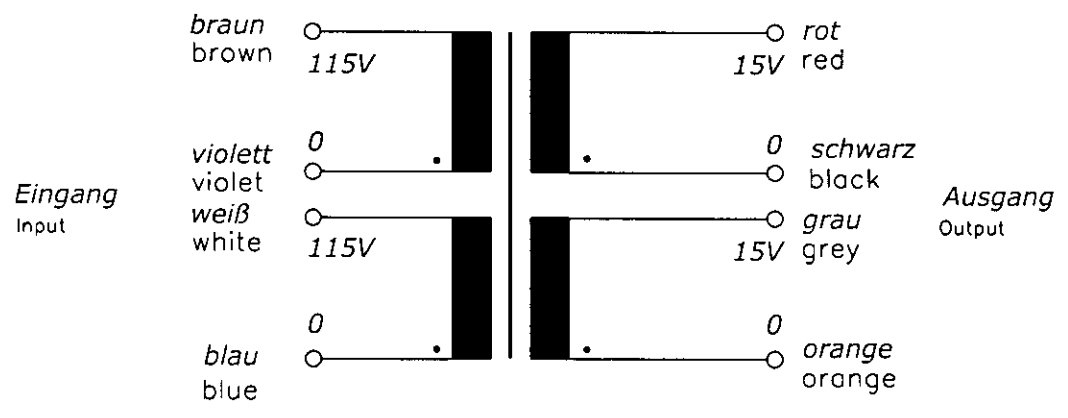

Abmessungen:
 Dimensions

Außen-Ø ca. 80mm im Bereich der Ausführungen ca. 83mm
 Outer-Ø approx. 80mm over leadouts approx. 83mm

Höhe max. 38mm zzgl. 5mm Montageset
 Height max. 38mm plus 5mm mounting kit

Gewicht: ca. 0,75kg
 Weight: approx. 0.75kg

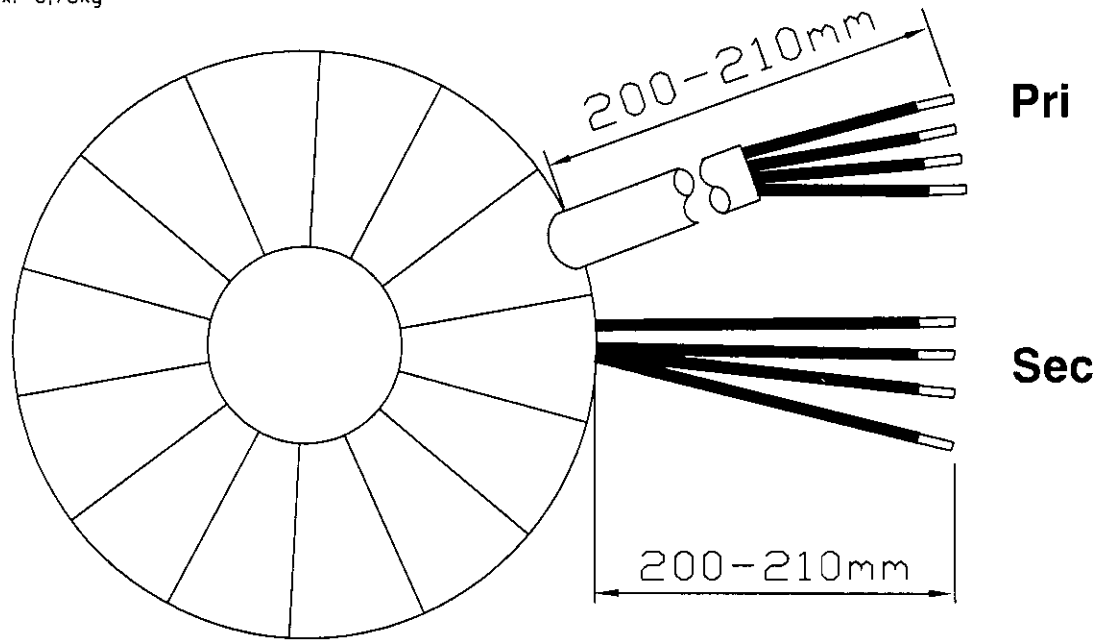

Befestigung mit (beiliegend):
 Mounting with (enclosed)

- 1x Befestigungscheibe**
1x Mounting plate
- 2x Gummischeibe**
2x Rubber disc
- 1x Schraube M6 + Scheibe + Mutter**
1x Screw M6 + washer + nut