

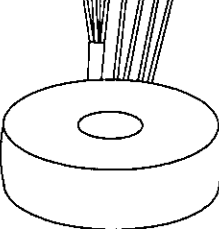



Typ Type	: 1~ Trenntransformator 1~ Isolating transformer		
Kernform Core type	: Ringbandkern Toroidal		
Bemessungsspannung, Eingang Designated input voltage	: 2x115V		
Bemessungsstrom, Eingang Designated input current	: 7,21Aac		
Bemessungsspannung, Ausgang Designated output voltage	: 2x 115V		
Bemessungsstrom, Ausgang Designated output current	: 6,96Aac		
Vorzusehende Absicherung, Ausgang Recommended output fuse	:  8,0AT		
Einschaltdauer Duty cycle	: 100%		
Bemessungsleistung (bei Leistungsfaktor 1) Designated output power (power factor 1)	: 1600VA		
Verlustleistung Power loss	: ca. 50,2W ($\eta \sim 96,9\%$) approx.		
Schaltgruppe Connection mode	: IIII0		
Betriebsfrequenz Designated frequency	: 50-60Hz		
Schutzklasse Safety class	: vorbereitet für Geräte der Schutzklasse II prepared for class II equipment		
Schutzart Protection index	: IP00		
Kühlungsart Type of cooling	: AN		
Isolierstoffklasse Insulation class	: B (UL class 105)		
Max. Umgebungstemperatur Ambient temperature	: 40°C		
Vorschriften Standards	: EN 61558 Teil 1 mit Teil 2-4 EN 61558 part 1 with part 2-4		
Prüfzeichen Approvals	:  UL 5085, CSA 22.2 (E 103521)		
Prüfspannung HV-Test voltage	: Primär-Sekundär 4,8 kV Primary-Secondary	Sekundär-Sekundär 1,0 kV Secondary-Secondary	
	Primär-Primär 0,3 kV Primary-Primary		
Anschluß (Eingang) Terminal (Input)	: 20-21cm UL/CSA-Litze Style 1015 AWG 16 20-21cm UL/CSA- AWM style 1015 AWG 16		
Anschluß (Ausgang) Terminal (Output)	: 20-21cm Drahtenden mit Gewebeschauch 20-21cm wire insulated with glass reinforced sleeving		
Bemerkungen Notes	: Die angegebenen technischen Daten sind typisch. Material- und fertigungsbedingt können Abweichungen auftreten. Technical specifications are typical, they can vary due to material and production tolerances.		

a	Date: 26.04.13	Name: Schlee	Date: 02.5.13	Checked: 	Amendment: Power loss added, HV-Test voltage changed
Date: 29.06.10	Date: 04.08.10	Schutzvermerk nach ISO 16016 beachten Observe protection clause to ISO 16016		Änderungen vorbehalten Subject to change	
Name: Jochade	Checked: Clasen				

Anschlußkennzeichnung:
 Terminal Identification

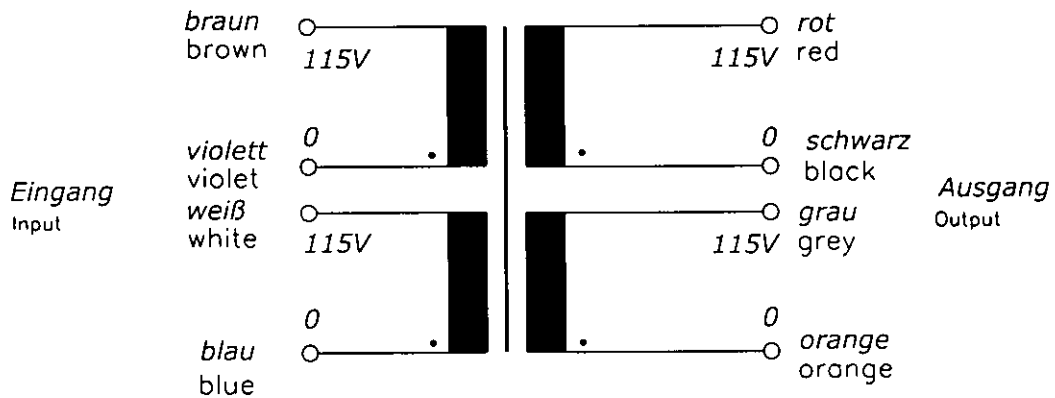

Abmessungen:
 Dimensions

Außen-Ø ca. 202mm im Bereich der Ausführungen ca. 205mm
 Outer-Ø approx. 202mm over leadouts approx. 205mm

Höhe max. 105mm
 Height max. 105mm

Gewicht: ca. 12,7kg
 Weight: approx. 12.7kg

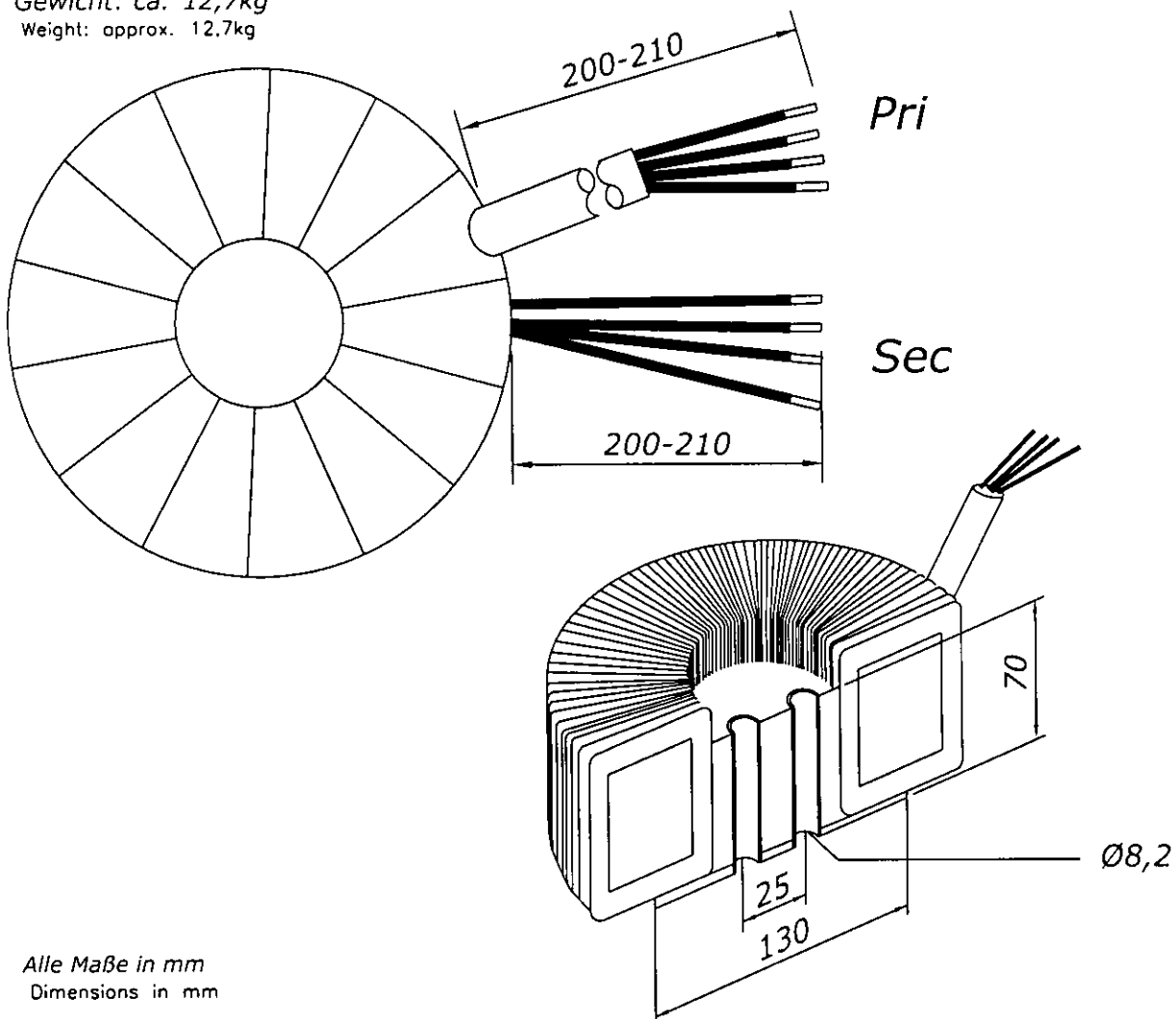

Alle Maße in mm
 Dimensions in mm

Seite 2/2
 Page 2/2