

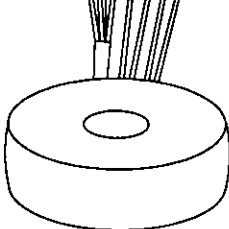



Typ Type	: 1~ Sicherheitstransformator 1~ Safety isolating transformer	
Kernform Core type	: Ringbandkern Torriodal	
Bemessungsspannung, Eingang Designated input voltage	: 2x115V	
Bemessungsstrom, Eingang Designated input current	: 0,48Aac	
Bemessungsspannung, Ausgang Designated output voltage	: 2x 12V	
Bemessungsstrom, Ausgang Designated output current	: 4,17Aac	
Vorzusehende Absicherung, Ausgang Recommended output fuse	:  4,0AT	
Einschaltdauer Duty cycle	: 100%	
Bemessungsleistung (bei Leistungsfaktor 1) Designated output power (power factor 1)	: 100VA	
Verlustleistung Power loss	: ca. 13,5W ($\eta \sim 88\%$) approx.	
Schaltgruppe Connection mode	: IIII0	
Betriebsfrequenz Designated frequency	: 50-60Hz	
Schutzklasse Safety class	: vorbereitet für Geräte der Schutzklasse II prepared for class II equipment	
Schutzart Protection index	: IP00	
Kühlungsart Type of cooling	: AN	
Isolierstoffklasse Insulation class	: B (UL class 105)	
Max. Umgebungstemperatur Ambient temperature	: 40°C	
Vorschriften Standards	: EN 61558 Teil 1 mit Teil 2-6 EN 61558 part 1 with part 2-6	
Prüfzeichen Approvals	:  UL 5085, CSA 22.2 (E 103521)	
Prüfspannung HV-Test voltage	: Primär-Sekundär 4,8 kV Sekundär-Sekundär 0,3 kV Primary-Secondary Secondary-Secondary : Primär-Primär 0,3 kV Primary-Primary	
Anschluß (Eingang) Terminal (Input)	: 20-21cm UL/CSA-Litze Style 1015 AWG 20 20-21cm UL/CSA- AWM style 1015 AWG 20	
Anschluß (Ausgang) Terminal (Output)	: 20-21cm Drahtenden mit Gewebeschauch 20-21cm wire insulated with glass reinforced sleeving	
Bemerkungen Notes	: Die angegebenen technischen Daten sind typisch. Material-und fertigungsbedingt können Abweichungen auftreten. Technical specifications are typical, they can vary due to material and production tolerances.	

a	Date: 23.04.13	Name: Schlee	Date: 25.4.13	Checked: 	Amendment: Eingangsleitung geändert/ Input wire changed
Date: 04.06.10		Date: 02.07.10		Schutzvermerk nach ISO 16016 beachten Observe protection clause to ISO 16016	
Name: Jochade		Checked: Thomas		Änderungen vorbehalten Subject to change	

Baureihe: **RKD**
Type:
Art.-Nr.: **RKD 100/2x12**
Art.-No.:

Datenblatt
Technical
Specifications

BLOCK
Transformatoren-Elektronik
GmbH
D - 27283 Verden/Aller

Anschlußkennzeichnung:
Terminal Identification

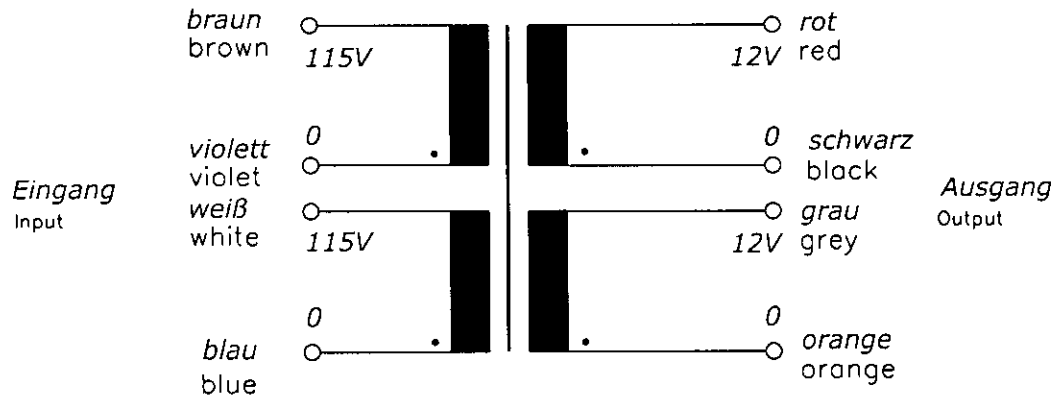

Abmessungen:
Dimensions

Außen-Ø ca. 92mm im Bereich der Ausführungen ca. 94mm
Outer-Ø approx. 92mm over leadouts approx. 94mm

Höhe max. 45mm zzgl. 5mm Montageset
Height max. 45mm plus 5mm mounting kit

Gewicht: ca. 1,2kg
Weight: approx. 1,2kg

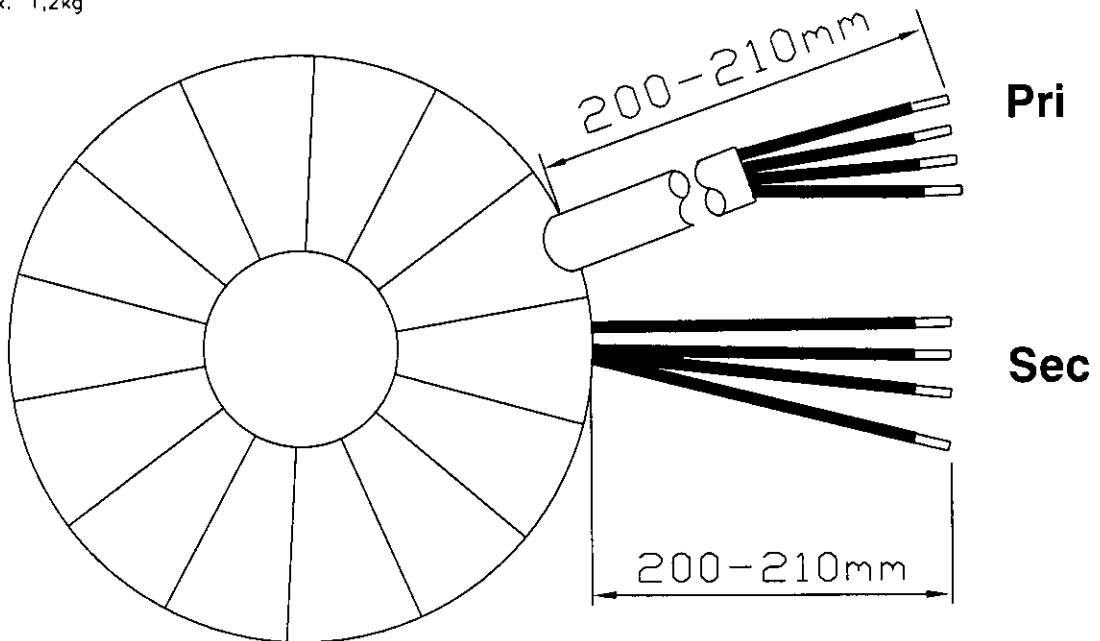

Befestigung mit (beiliegend):
Mounting with (enclosed)

1x Befestigungscheibe
1x Mounting plate

2x Gummischeibe
2x Rubber disc

1x Schraube M6 + Scheibe + Mutter
1x Screw M6 + washer + nut

Seite 2/2
Page 2/2